



Leading Cable Management Solutions

COMPANY PROFILE.

Providing high-quality, reliable cable tray systems for major infrastructure projects across the Middle East.

AB-COPE COMPANY PROFILE v1.0



Abahsain Cope Saudi Arabia Co. Ltd. (ab-cope) is a leading manufacturer of comprehensive cable management solutions based in the Kingdom of Saudi Arabia. Established as a joint venture, ab-cope combines decades of local industrial expertise from the Saleh & Abdulaziz Abahsain Group with international manufacturing standards from T.J. Cope Inc. (USA) to provide high-quality, reliable, and innovative cable tray systems.

Our solutions cater to major infrastructure projects across diverse sectors, including oil & gas, petrochemical, power, water, and telecommunications. Our commitment to quality, safety, and customer satisfaction makes us a trusted partner for engineering and project management needs in the region and beyond.



2024 : Saleh & Abdulaziz Abahsain Group - Meeting Room



2024 : Saleh & Abdulaziz Abahsain Group

Our Heritage

AB-COPE's roots trace back to **1947**, when the Saleh & Abdulaziz Abahsain Group, Saudi Arabia's first electrical contractor began supporting the Kingdom's rapidly expanding infrastructure needs.

In **1981**, Abahsain Cope Saudi Arabia Co. Ltd. was formed as a joint venture with T.J. Cope Inc. (USA), introducing advanced cable management manufacturing to the region. Throughout the **1980s**, the company expanded its local production capabilities with new product lines and modern industrial systems.

By **2000**, AB-COPE completed its transition to a fully Saudi-owned company after concluding its partnership with T.J. Cope/Tyco. The company retained the AB-COPE name, preserving its established identity and engineering legacy.

Today, AB-COPE continues to build on more than four decades of manufacturing excellence, serving major sectors with trusted, high-quality cable management solutions



1981 : Saleh & Abdulaziz Abahsain Group

Expansion Joint Venture

Formation of Abahsain Cope Saudi Arabia Co. Ltd. as a joint venture with T.J. Cope Inc. (USA).

Launch Cope-Tray Systems

Launch of Cope-Tray cable management systems, setting new industry standards.

Present Leading Manufacturer

Serving oil & gas, petrochemical, power, water, and infrastructure sectors.



1947

Foundation

Establishment of Group

Establishment of the [Saleh & Abdulaziz Abahsain Group](#), the first electrical contractor in Saudi Arabia.



1981



1983

Innovation

Unistrut Systems

Introduction of Unistrut metal framing systems, enhancing construction capabilities.



1985



2000

Milestone

%100 Saudi Ownership

Full transition to %100 Saudi ownership. AB-COPE name retained for heritage.



Today

Our Vision, Mission & Values



Vision

To be the global benchmark for cable management solutions, driving industry innovation and technological advancement from the heart of Saudi Arabia.



Mission

To be the global benchmark for cable management solutions, driving industry innovation and technological advancement from the heart of Saudi Arabia.



Values

To be the global benchmark for cable management solutions, driving industry innovation and technological advancement from the heart of Saudi Arabia.



Our Products & Services

Cable Tray Systems

- AB-Cope Swage Ladder (Patented)
- AB-Cope I-BEAM (Heavy Duty)
- AB-Cope Hat Rung (Flange-in)
- AB-Cope Trof (Ventilated & Solid)
- AB-Cope Channel
- AB-Cope Wire Basket (Kwik-Latch)
- AB-Cope Glas (FRP/GRP - Corrosion Resistant)

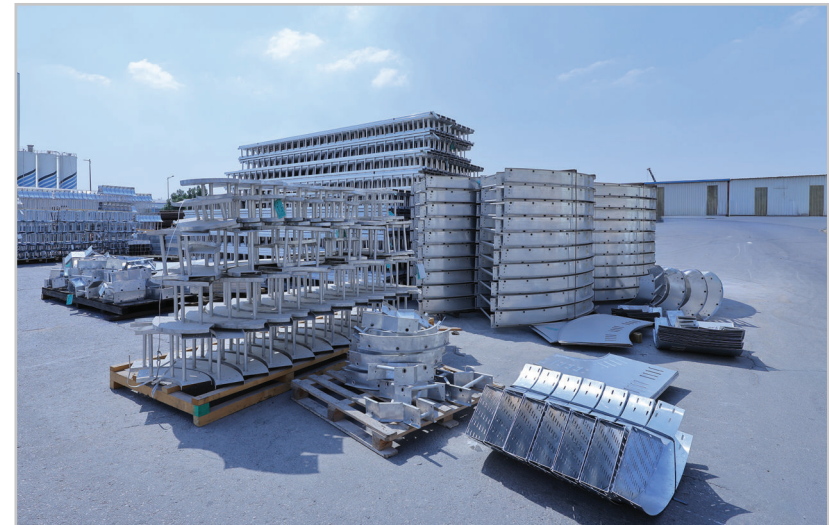
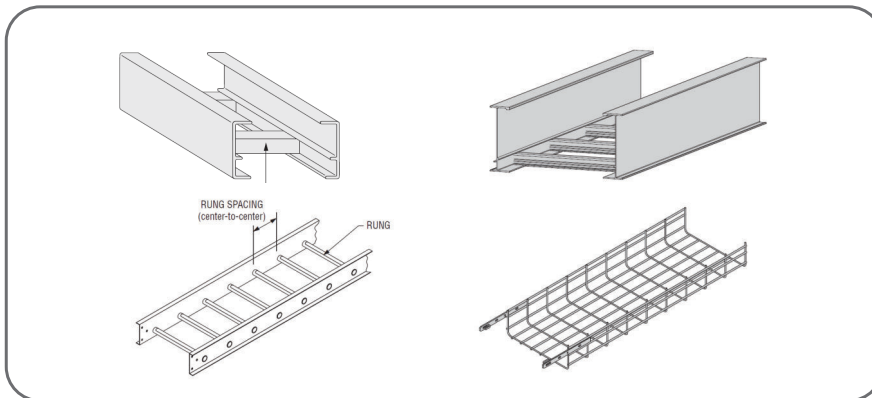

Our Products & Services

Support & Power Systems

- Unistrut Metal Framing
- Cable Trunking Systems
- Cable Bus System (Power Transmission)
- Busways / Busbar Trunking System
- Cable Runway Systems
- Cable Racks & Hook Systems

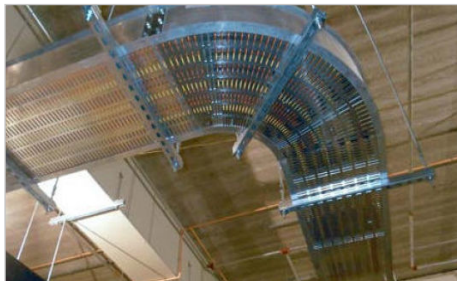

Accessories

- Comprehensive Fittings & Connectors
- Covers (Flat, Peaked, Vented)
- Barrier Strips & Clamps
- Hold Down Clamps & Expansion Guides
- Supports, Hangers & Brackets
- Earthing, Grounding & Lightning Protection
- Explosion Proof LED Lighting & Junction Boxes

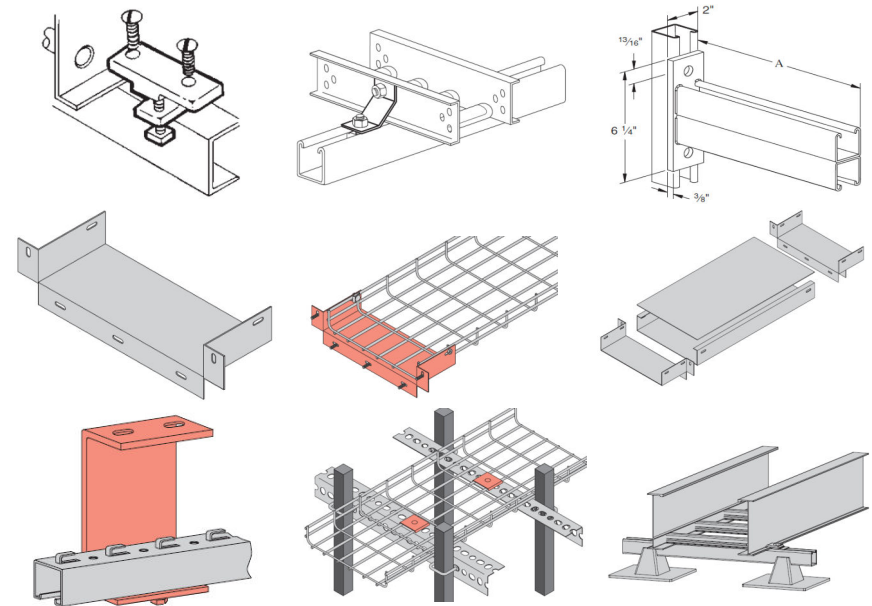

Manufacturing Excellence & Capacity

Our state-of-the-art facilities in Dammam utilize advanced processes like CNC perforation and cold swaging for superior connections. A key strategic advantage is our **in-house Hot Dip Galvanizing Plant located within the same yard**, ensuring complete quality control and faster turnaround times.

We offer various materials (Aluminum, Steel, Stainless Steel, Fiberglass) and finishes (Mill-Galv., HDGAF) conforming to ASTM, NEMA, and CSA standards. Our approximate monthly capacity is 800-600 Tons.



800
Tons

Maximum monthly production capacity

6K
Units

Cable ladder & tray monthly output

30K
Pieces

Unistrut channel monthly capacity

Manufacturing Excellence & Capacity Overview

Product Category	Capacity (Pcs)	Distribution Share
Unistrut Channel	30,000	%47.6
Accessories	15,000	%23.8
Cable Ladder	6,000	%9.5
Cable Tray	6,000	%9.5
Cable Trunking / Trough	3,000	%4.8

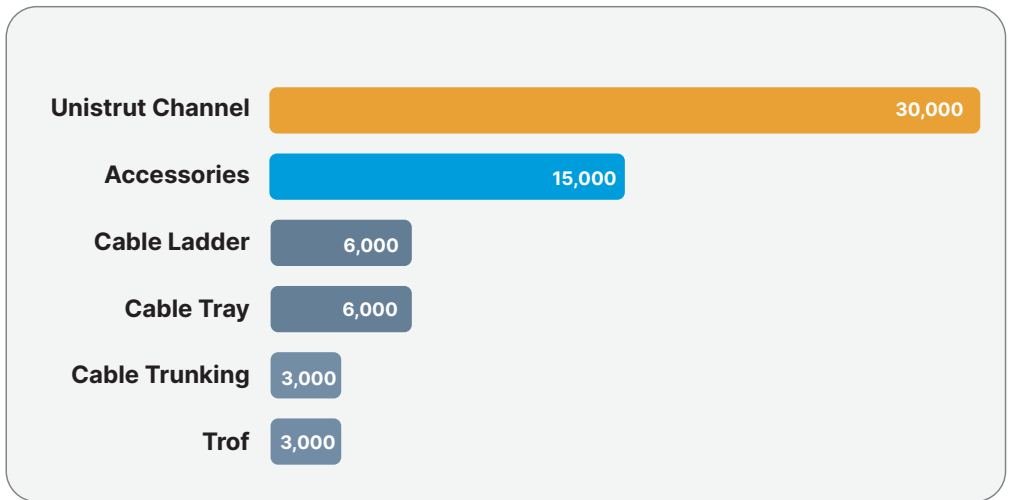

Unistrut Channel production leads significantly, representing nearly %48 of total manufacturing capacity.

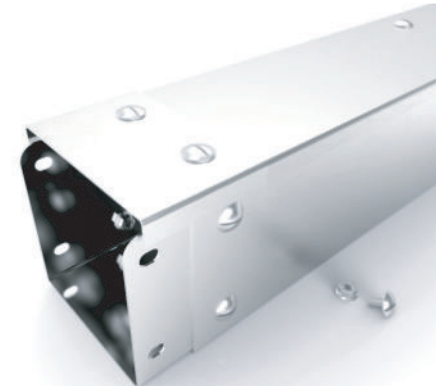

Major Projects Overview

Strategic Partnerships & Mega Project Execution (2021 - 2024)

📅 Last 3 Years Highlight

 **Key Client: Saudi Aramco**

aramco 

TOP PROJECT

King Salman Maritime Yard

Client: SEPCO

VALUE EXCEEDING

70M 

Ras Al Khair

SABIC / Petrochemicals 

PDH/UTOS Project 2023

CLIENT: SAMSUNG ENGINEERING (APOC)

Ibn Zahir Project 2021

CLIENT: JAL INTERNATIONAL

Recent Major Executions (2024-2023)

Jafurah Phase II (Pkg-31) Gas Field

L&T HYDROCARBON | 2024

Riyadh Refinery Refinery

TECHNIP ENERGIES | 2024

Zuluf Project Oil & Gas

JGC CORPORATION | 2023

Marjan Pkg #14# & 6 Offshore

HYUNDAI E&C / NESMA | 2022 - 2023

Jafurah NGL NGL

ENNPI | 2024

Ma'aden & Mining 

Mansourah Massarah Gold 2021

DAP NPK Plant 2020

CLIENT: INTECSA/DRAGADOS

SEC & Power 

Al Aseel Project 2021

Global Project Footprint

Delivering Excellence Across the GCC, Africa & Asia

United Arab Emirates

- Borouge Polyethylene Plant
- Ruwais Refinery Expansion
- Dubai Natural Gas Expansion
- Abu Dhabi Substation



Qatar

- Ras Laffan LNG Train #3
- QAFCO III Expansion
- Dolphin Project (DOPET)



Kuwait & Bahrain

- Refinery Restoration (Kuwait)
- Equate Project (Kuwait)
- Alba Potline 6 ,5 ,4 (Bahrain)
- Salmaniyah Hospital (Bahrain)



Asia & Africa

- Australia: PNG LNG EPC4
- Sudan: Muglad Basin Project
- Philippines: Tongonan Geo.
- Egypt: Lube Oil Blending















Core Market: KSA

Extensive portfolio covering Eastern, Central, and Western regions, supporting Vision 2030 initiatives.





Jubail Yanbu Jazan Ras Al Khair

Extended Project Reference

Project Name	Location/Client	Year
BPC Jubail	 KSA / Aramco	2023
Juaymah Project	 KSA / ENNPI	2023
Western Libya Gas	 Libya / AGIP BV	2014
Sadad Refinery Upgrade	 Oman / PDO	2014
Lube Oil Blending Plant	 Egypt / Misr Petroleum	2013
Shoaiba Phase I / II	 KSA / SWCC	2013
Jordan Bromine Project	 Jordan / AMEC	2012
Shaybah #1, #2, #3	 KSA / Samsung	2012
Al Furat Expansion	 Syria / Al Furat	2011
Muglad Basin Project	 Sudan / EPCC	2010
Tongonan Geothermal	 Philippines / PNOG	2010
PNG LNG EPC4	 Australia / Papua New Guinea	2009
O-Chem	 Qatar / Technip	2009

Quality, Health, Safety & Environment (QHSE)

Abahsain Cope is committed to the highest standards of QHSE management. Our operations adhere to rigorous international standards, demonstrated by our certifications and permits:

-  ISO 9001:2015 (Quality Management)
-  ISO 14001:2015 (Environmental Management)
-  ISO 45001:2018 (Occupational Health & Safety)
-  Environmental Permit from The General Authority of Meteorology & Environmental Protection (GAMEP)

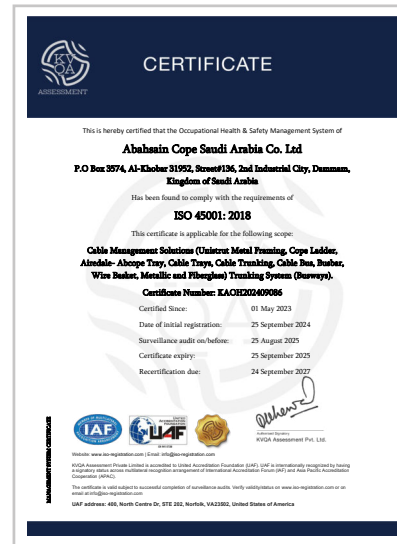
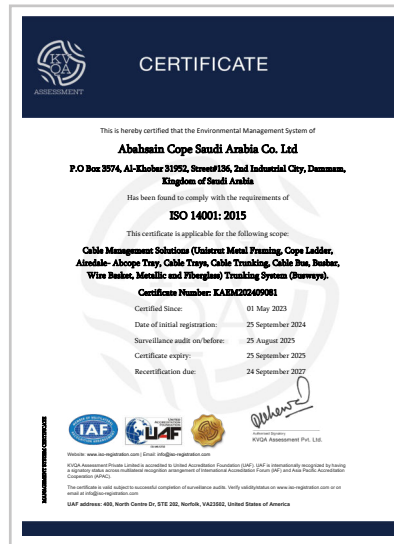
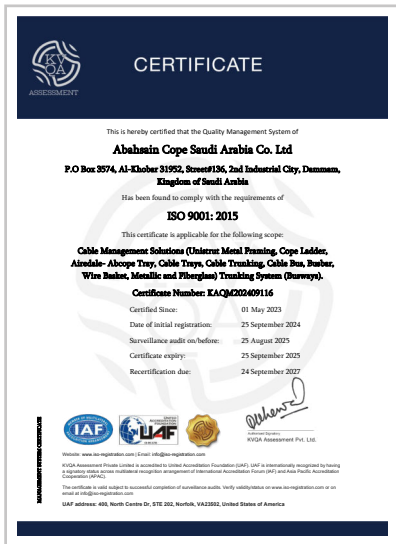

These credentials ensure our products and processes consistently meet regulatory requirements and customer expectations while prioritizing employee well-being and environmental protection.

Approvals & Main Clients

Our products are approved and trusted by major organizations across the region, demonstrating our reliability and adherence to strict standards.

aramco 

سابك
SABIC

الشركة السعودية للكهرباء
Saudi Electricity Company

المؤسسة العامة لتحلية المياه المالحة
Saline Water Conversion Corporation 

مرافق
MARAFIQ

الهيئة الملكية
للجubil وبنبع
Royal Commission for Jubail & Yanbu 

EWA
هيئة الكهرباء والماء
Electricity & Water Authority 

أدنوك
ADNOC 

شركة تنمية نفط عمان
Petroleum Development Oman 

شركة نفط الكويت
Kuwait Oil Company 

قطر للبترول
Qatar Petroleum 

SAMSUNG

معدن
MAADEN 

HYUNDAI 

LARSEN & TOUBRO 

Organization Chart

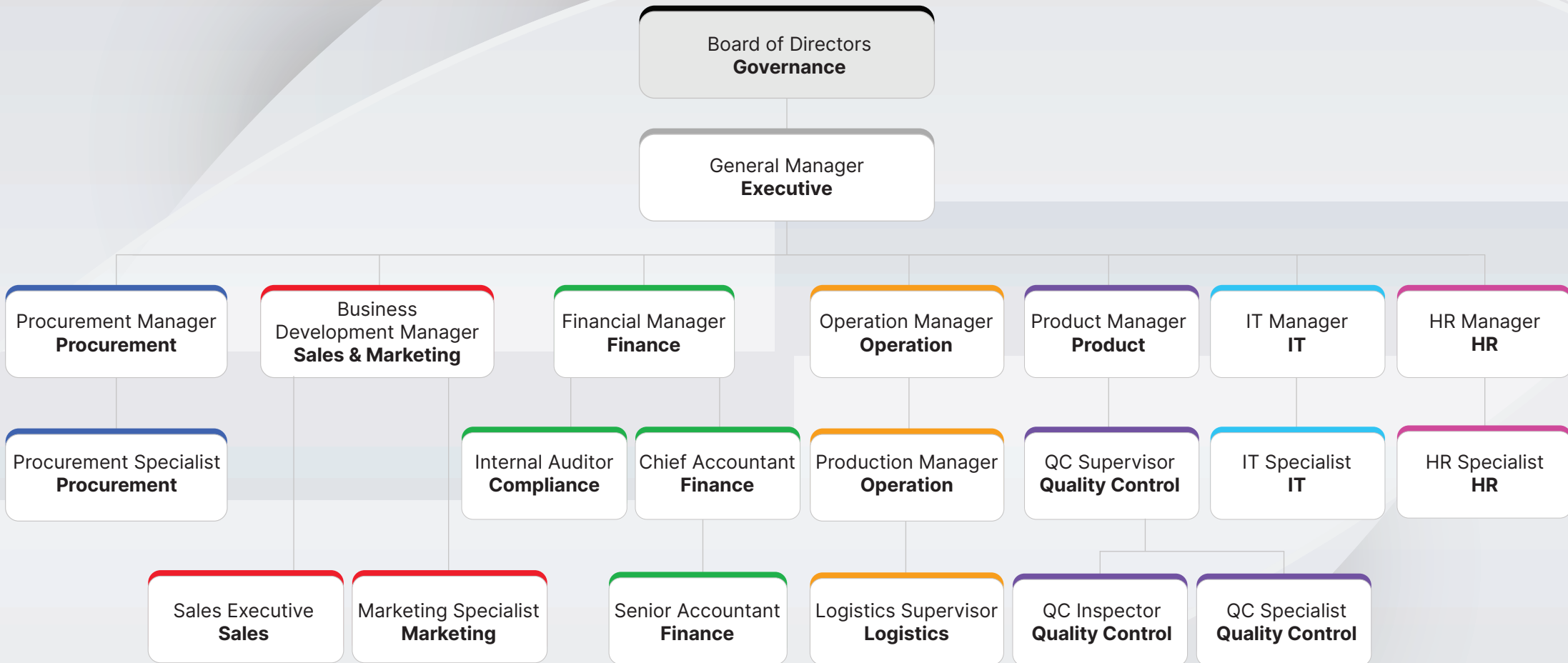

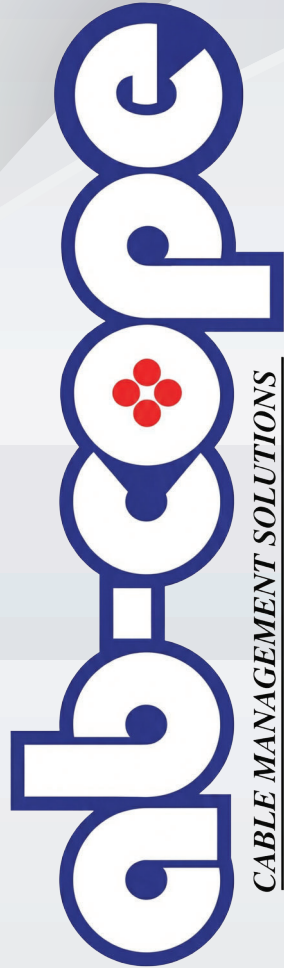

CONTACT US



Location:

Street No. 136, 2nd Industrial City, Dammam, KSA



Contact:

+966 13 833 3583

+966 13 808 6568



Fax:

+966 13 899 1557



Email:

abcope@abahsain.net



<https://www.abcope.sa>